



# ELEMENTI

SNAIDERO  
DESIGN





**Anta sp.**

*Door th. / Façade Ép. / Puerta Esp.*

21 / 23,5 mm

**H. fusto mobili base**

*H. Base units carcasses / H. Caisson meubles bas / H. Casco muebles bajos*

81 cm

**Estraibili**

*Pull-out / Coulissant / Extraible*

**Antaro  
Legrabox  
Ta'or**

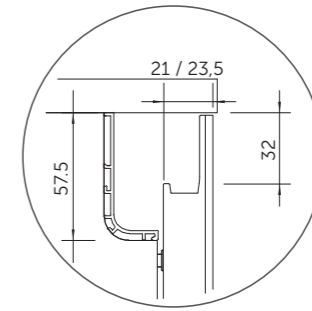
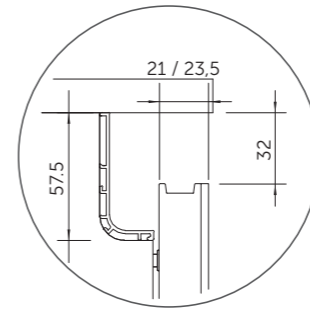

**Profilo gola**

*Channel profile  
Profils à gorge  
Perfil gola*

**Colorazioni Fusti**

*Carcasses colours / Couleurs Caisson / Colores Casco*



**1W**  
Bianco Igloo  
*Igloo White  
Blanc IGLOO  
Blanco IGLÚ*



**2R**  
Grigio Texture  
*Texture Grey  
Gris Texture  
Gris Texture*



**24**  
Grigio Monolite  
*Monolith Grey  
Gris Monolithe  
Gris Monolito*



**25**  
Grigio Status  
*Status Grey  
Gris Status  
Gris Status*

**Colore telaio anta**

*Door frame colour  
Couleur du cadre de la porte  
Color del marco de la puerta*

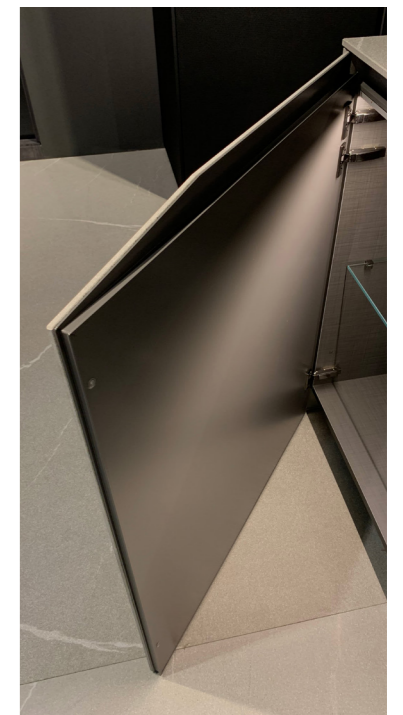

Nero  
Black  
Noir  
Negro

# ELEMENTI Finiture

Finishes / Finitions / Acabados

## VETRI LUCIDI / TELAIO ALLUMINIO - 21mm

HIGH GLOSS GLASSES / ALUMINIUM FRAME 21 mm / VERRES BRILLANTS / CADRE ALUMINIUM 21 mm / VIDRIOS BRILLOS / MARCO ALUMINIO 21 mm

Colonna prezzo / Price column  
Colonne prix / Columna precio

15

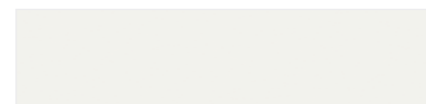

1V **BIANCO ARTICO** / ARCTIC WHITE  
BLANC ARCTIQUE / BLANCO ÁRTICO

Attenzione: in caso di sostituzioni o completamenti a causa della natura del materiale, leggere differenze di tono/effetto non sono da potersi considerare difetti ma caratteristiche intrinseche del prodotto.

Attention: please note that due to the nature, slight variations in the tone/effct, occurring in case of remedials or additional parts, shall not be viewed as defects but intrinsic peculiarities of product.

Attention: en raison de la nature de la matière, en cas de remplacements ou éléments supplémentaires, des légères variations de tonalité/effet ne sont pas des défauts mais des caractéristiques intrinsèques du produit.

Atención: en caso de reemplazos o pedidos adicionales, debido a la naturaleza del material, las pequeñas deferencias en el tono/efecto no deben considerarse defectos, sino características intrínsecas del producto

## VETRI LUCIDI / TELAIO ALLUMINIO - 21mm

HIGH GLOSS GLASSES / ALUMINIUM FRAME 21 mm / VERRES BRILLANTS / CADRE ALUMINIUM 21 mm / VIDRIOS BRILLOS / MARCO ALUMINIO 21 mm

Colonna prezzo / Price column  
Colonne prix / Columna precio

16

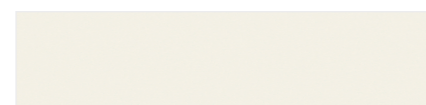

2B **GRIGIO PIUMA** / FEATHER GREY  
GRIS PLUME / GRIS PLUMA



E2 **GRIGIO ATLANTICO** / ATLANTIC GREY  
GRIS ATLANTIQUE / GRIS ATLÁNTICO



F2 **GRIGIO GRAFITE** / GRAPHITE GREY  
GRIS GRAPHITE / GRIS GRAFITO

Attenzione: in caso di sostituzioni o completamenti a causa della natura del materiale, leggere differenze di tono/effetto non sono da potersi considerare difetti ma caratteristiche intrinseche del prodotto.

Attention: please note that due to the nature, slight variations in the tone/effct, occurring in case of remedials or additional parts, shall not be viewed as defects but intrinsic peculiarities of product.

Attention: en raison de la nature de la matière, en cas de remplacements ou éléments supplémentaires, des légères variations de tonalité/effet ne sont pas des défauts mais des caractéristiques intrinsèques du produit.

Atención: en caso de reemplazos o pedidos adicionales, debido a la naturaleza del material, las pequeñas deferencias en el tono/efecto no deben considerarse defectos, sino características intrínsecas del producto

## VETRI OPACHI / TELAIO ALLUMINIO - 21mm

SATIN GLASSES / ALUMINIUM FRAME 21mm / VERRES DÉPOLIS / CADRE ALUMINIUM 21mm / VIDRIOS MATE / MARCO ALUMINIO 21mm

Colonna prezzo / Price column  
Colonne prix / Columna precio

16

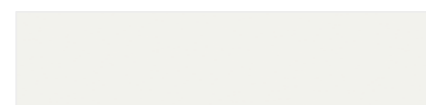

1V **BIANCO ARTICO** / ARCTIC WHITE  
BLANC ARCTIQUE / BLANCO ÁRTICO



2B **GRIGIO PIUMA** / FEATHER GREY  
GRIS PLUME / GRIS PLUMA



E2 **GRIGIO ATLANTICO** / ATLANTIC GREY  
GRIS ATLANTIQUE / GRIS ATLÁNTICO



F2 **GRIGIO GRAFITE** / GRAPHITE GREY  
GRIS GRAPHITE / GRIS GRAFITO

Attenzione: in caso di sostituzioni o completamenti a causa della natura del materiale, leggere differenze di tono/effetto non sono da potersi considerare difetti ma caratteristiche intrinseche del prodotto.

Attention: please note that due to the nature, slight variations in the tone/effct, occurring in case of remedials or additional parts, shall not be viewed as defects but intrinsic peculiarities of product.

Attention: en raison de la nature de la matière, en cas de remplacements ou éléments supplémentaires, des légères variations de tonalité/effet ne sont pas des défauts mais des caractéristiques intrinsèques du produit.

Atención: en caso de reemplazos o pedidos adicionales, debido a la naturaleza del material, las pequeñas deferencias en el tono/efecto no deben considerarse defectos, sino características intrínsecas del producto

# ELEMENTI Finiture

Finishes / Finitions / Acabados

## CERAMICHE / TELAIO ALLUMINIO - 23,5mm

CERAMICS / ALUMINIUM FRAME - 23,5mm / CÉRAMIQUES / CADRE ALUMINIUM - 23,5mm / CERÁMICAS / MARCO EN ALUMINIO - 23,5mm

Colonna prezzo / Price column  
Colonne prix / Columna precio

17

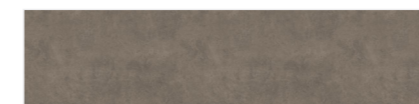

GK **FOKOS ROCCIA** / FOKOS ROCK  
FOKOS ROCHER / FOKOS ROCA

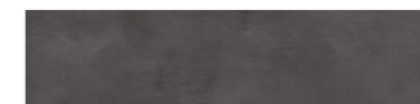

DS **CALCE NERO** / CALCE NERO  
CALCE NERO / CALCE NEGRO



DG **CALCE GRIGIO** / CALCE GRIGIO  
CALCE GRIGIO / CALCE GRIS



D1 **CALCE BIANCO** / CALCE BIANCO  
CALCE BIANCO / CALCE BLANCO



DZ **OSSIDO NERO** / OSSIDO NERO  
OSSIDO NERO / ÓXIDO NEGRO

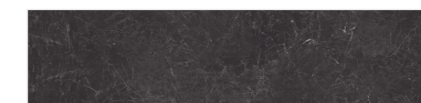

9H **NERO GRECO** / GREEK BLACK  
NOIR GRECO / NEGRO GRIEGO



83 **DIAMOND CREAM** / DIAMOND CREAM  
DIAMOND CREAM / DIAMOND CREAM

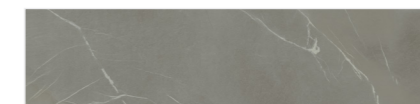

2T **PIETRA PIASENTINA** / PIASENTINA STONE  
PIERRE PIASENTINA / PIEDRA PIASENTINA

Attenzione: in caso di sostituzioni o completamenti a causa della natura del materiale, leggere differenze di tono/effetto non sono da potersi considerare difetti ma caratteristiche intrinseche del prodotto.

Attention: please note that due to the nature, slight variations in the tone/effct, occurring in case of remedials or additional parts, shall not be viewed as defects but intrinsic peculiarities of product.

Attention: en raison de la nature de la matière, en cas de remplacements ou éléments supplémentaires, des légères variations de tonalité/effet ne sont pas des défauts mais des caractéristiques intrinsèques du produit.

Atención: en caso de reemplazos o pedidos adicionales, debido a la naturaleza del material, las pequeñas deferencias en el tono/efecto no deben considerarse defectos, sino características intrínsecas del producto

## VETRI INTRECCIATI / TELAIO ALLUMINIO - 22mm

BRAIDED-FINISH GLASS / ALUMINIUM FRAME - 22mm / VERRE TRESSÉ / CADRE ALUMINIUM - 22mm / VIDRIO TRENZADO / MARCO ALUMINIO - 22mm

Colonna prezzo / Price column  
Colonne prix / Columna precio

18

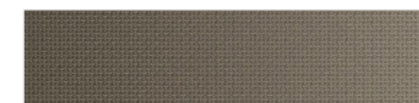

HB **BRONZO INTRECCIATO** / BRAIDED-FINISH GLASS BRONZE  
BRONZE TRESSÉ / BRONCE TRENZADO



2S **PLATINO INTRECCIATO** / BRAIDED-FINISH GLASS PLATINUM  
PLATINE TRESSÉ / PLATINO TRENZADO

Attenzione: in caso di sostituzioni o completamenti a causa della natura del materiale, leggere differenze di tono/effetto non sono da potersi considerare difetti ma caratteristiche intrinseche del prodotto.

Attention: please note that due to the nature, slight variations in the tone/effct, occurring in case of remedials or additional parts, shall not be viewed as defects but intrinsic peculiarities of product.

Attention: en raison de la nature de la matière, en cas de remplacements ou éléments supplémentaires, des légères variations de tonalité/effet ne sont pas des défauts mais des caractéristiques intrinsèques du produit.

Atención: en caso de reemplazos o pedidos adicionales, debido a la naturaleza del material, las pequeñas deferencias en el tono/efecto no deben considerarse defectos, sino características intrínsecas del producto



# ELEMENTI Tabella Abbinamenti Finiture

Finishes Matching Table / Tableau de correspondance des finitions / Tabla de combinación de acabados

## FINITURE LAMINAM ANTE SP.5+ - 6MM / LAMINAM FINISHES FOR DOORS TH.5+ - 6MM / FINITIONS LAMINAM PORTES ÉP.5+ - 6MM / ACABADOS LAMINAM PUERTAS ESP.5+ - 6MM

DIAMOND CREAM / DIAMOND CREAM / DIAMOND CREAM / DIAMOND CREAM	LACCATO OPACO GRIGIO PIUMA / FEATHER GREY MATT LACQUER / LAQUÉ MAT GRIS PLUME / LACADO MATE GRIS PLUMA
PIETRA PIASENTINA / PIASENTINA STONE / PIERRE PIASENTINA / PIEDRA PIASENTINA	LACCATO OPACO TITANIO / TITANIUM MATT LACQUER / LAQUÉ MAT TITANE / LACADO MATE TITANIO
FOKOS ROCCIA / FOKOS ROCK / FOKOS ROCHER / FOKOS ROCA	LACCATO OPACO TITANIO / TITANIUM MATT LACQUER / LAQUÉ MAT TITANE / LACADO MATE TITANIO
CALCE GRIGIO / CALCE GRIGIO / CALCE GRIGIO / CALCE GRIS	GRIGIO ATLANTICO SATINATO / SATIN ATLANTIC GRAY / GRIS ATLANTIQUE MAT / GRIS ATLÁNTICO SATINADO
CALCE BIANCO / CALCE BIANCO / CALCE BIANCO / CALCE BLANCO	GRIGIO PIUMA SATINATO / MATT FEATHER GREY / GRIS PLUME MAT / GRIS PLUMA SATINADO
OSSIDO NERO / OSSIDO NERO / OSSIDO NERO / ÓXIDO NEGRO	LACCATO MICALIZZATO NERO EXTRA / MICALISED LACQUERS EXTRA BLACK / NOIR EXTRA LAQUÉS MICALISÉS / LACADO MICALIZADO NEGRO EXTRA
CALCE NERO / CALCE NERO / CALCE NERO / CALCE NEGRO	LACCATO MICALIZZATO NERO EXTRA / MICALISED LACQUERS EXTRA BLACK / NOIR EXTRA LAQUÉS MICALISÉS / LACADO MICALIZADO NEGRO EXTRA
NERO GRECO / GREEK BLACK / NOIR GRECO / NEGRO GRIEGO	LACCATO MICALIZZATO NERO EXTRA / MICALISED LACQUERS EXTRA BLACK / NOIR EXTRA LAQUÉS MICALISÉS / LACADO MICALIZADO NEGRO EXTRA

## FINITURE VETRO SCILM - 4MM / SCILM GLASS FINISHES - 4MM / FINITIONS VERRE SCILM - 4MM / ACABADOS VIDRIO SCILM - 4MM

BIANCO ARTICO LUCIDO / GLOSSY ARCTIC WHITE / BLANC ARCTIQUE BRILLANT / BLANCO ÁRTICO BRILLANTE	BIANCO ARTICO LUCIDO / GLOSSY ARCTIC WHITE / BLANC ARCTIQUE BRILLANT / BLANCO ÁRTICO BRILLANTE
GRIGIO PIUMA LUCIDO / GLOSSY FEATHER GREY / GRIS PLUME BRILLANT / GRIS PLUMA BRILLANTE	GRIGIO PIUMA LUCIDO / GLOSSY FEATHER GREY / GRIS PLUME BRILLANT / GRIS PLUMA BRILLANTE
GRIGIO ATLANTICO LUCIDO / GLOSSY ATLANTIC GREY / GRIS ATLANTIQUE BRILLANT / GRIS ATLÁNTICO BRILLANTE	GRIGIO ATLANTICO LUCIDO / GLOSSY ATLANTIC GREY / GRIS ATLANTIQUE BRILLANT / GRIS ATLÁNTICO BRILLANTE
GRIGIO GRAFITE LUCIDO / GLOSSY ATLANTIC GREY / GRIS GRAPHITE BRILLANT / GRIS GRAFITO BRILLANTE	GRIGIO GRAFITE LUCIDO / GLOSSY ATLANTIC GREY / GRIS GRAPHITE BRILLANT / GRIS GRAFITO BRILLANTE
BIANCO ARTICO SATINATO / MATT ARCTIC WHITE / BLANC ARCTIQUE MAT / BLANCO ÁRTICO SATINADO	BIANCO ARTICO SATINATO / MATT ARCTIC WHITE / BLANC ARCTIQUE MAT / BLANCO ÁRTICO SATINADO
GRIGIO PIUMA SATINATO / MATT FEATHER GREY / GRIS PLUME MAT / GRIS PLUMA SATINADO	GRIGIO PIUMA SATINATO / MATT FEATHER GREY / GRIS PLUME MAT / GRIS PLUMA SATINADO
GRIGIO ATLANTICO SATINATO / SATIN ATLANTIC GRAY / GRIS ATLANTIQUE MAT / GRIS ATLÁNTICO SATINADO	GRIGIO ATLANTICO SATINATO / SATIN ATLANTIC GRAY / GRIS ATLANTIQUE MAT / GRIS ATLÁNTICO SATINADO
GRIGIO GRAFITE SATINATO / MATT ATLANTIC GREY / GRIS GRAPHITE MAT / GRIS GRAFITO SATINADO	GRIGIO GRAFITE SATINATO / MATT ATLANTIC GREY / GRIS GRAPHITE MAT / GRIS GRAFITO SATINADO

## FINITURE GOLDEN GLASS - 4,5MM / GOLDEN GLASS FINISHES - 4,5MM / FINITIONS GOLDEN GLASS - 4,5MM / ACABADOS GOLDEN GLASS - 4,5MM

BRONZO INTRECCIATO / BRAIDED-FINISH GLASS BRONZE / BRONZE TRESSÉ / BRONCE TRENZADO	METALLIZZATO ORO BRUNITO / METALLISED BURNISHED GOLD / MÉTALLISÉ OR BRUNI / ORO BRUÑIDO METALIZADO
PLATINO INTRECCIATO / BRAIDED-FINISH GLASS PLATINUM / PLATINE TRESSÉ / PLATINO TRENZADO	METALLIZZATO GRIGIO PIOMBO / METALLISED LEAD GRAY / MÉTALLISÉ GRIS PLOMB / GRIS PLOMO METALIZADO

LE FINITURE INDICATE NON RIPRODUCONO LA FINITURA REALE DEL MATERIALE. SONO DEGLI ABBINAMENTI PER SIMILITUDINE PERTANTO NON VERRANNO ACCETTATE EVENTUALI CONTESTAZIONI. DA UTILIZZARE ESCLUSIVAMENTE PER ELEMENTI NON REALIZZABILI PER LIMITI DIMENSIONALI DI LAVORAZIONE DEL MATERIALE.

I MONTANTI ANGOLARI DEI PENSILI DI SERIE VERRANNO FORNITI NELLE FINITURE IN ABBINAMENTO

THE FINISHES INDICATED DO NOT REPRODUCE THE REAL FINISH OF THE MATERIAL, THEY ARE COMBINATIONS FOR SIMILARITY THEREFORE ANY DISPUTES WILL NOT BE ACCEPTED. TO BE USED EXCLUSIVELY FOR ELEMENTS THAT CANNOT BE MANUFACTURED DUE TO DIMENSIONAL LIMITS IN THE PROCESSING OF THE MATERIAL. CORNER POSTS FOR STANDARD WALL UNITS WILL BE SUPPLIED IN A MATCHING FINISH

LES FINITIONS INDIQUÉES NE REPRODUISENT PAS LA FINITION RÉELLE DU MATÉRIAU, CE SONT DES COMBINAISONS PAR SIMILITUDE DONC AUCUNE CONTESTATION NE SERA ACCEPTÉE. À UTILISER EXCLUSIVEMENT POUR LES ÉLÉMENTS QUI NE PEUVENT PAS ÊTRE FABRIQUÉS EN RAISON DES LIMITES DIMENSIONNELLES DANS L'USINAGE DU MATÉRIAU.

LES MONTANTS D'ANGLE DES MEUBLES HAUTS STANDARD SERONT FOURNIS DANS LES FINITIONS CORRESPONDANTES



LOS ACABADOS INDICADOS NO REPRODUCEN EL ACABADO REAL DEL MATERIAL, SON COMBINACIONES POR SEMEJANZA POR LO QUE NO SE ACEPTARÁN DISPUTAS. UTILIZAR EXCLUSIVAMENTE PARA ELEMENTOS QUE NO SE PUEDEN FABRICAR POR LIMITACIONES DIMENSIONALES EN EL PROCESAMIENTO DEL MATERIAL. LOS MONTANTES RINCONEROS DE LOS MUEBLES ALTOS ESTÁNDAR SE SUMINISTRARÁN EN ACABADOS A JUEGO

# ELEMENTI Profili gola

Channel profiles / Profils à gorge / Perfil gola

## ALLUMINIO ANODIZZATO

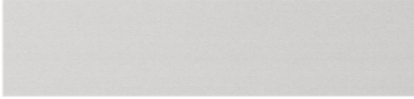
ANODIZED ALUMINUM / ALUMINIUM ANODISÉ / ALUMINIO ANODIZADO

		
<b>HX</b> ACCIAIO INOX / STAINLESS STEEL ACIER INOX / ACERO INOXIDABLE	<b>H7</b> TITANIO / TITANIUM TITANE / TITANIO	<b>90</b> NERO / BLACK NOIR / NEGRO

## ALLUMINIO VERNICIATO A POLVERI

POWDER-COATED ALUMINUM / ALUMINIUM LAQUÉ POUFRE / ALUMINIO BARNIZADO CON POLVO

	
<b>01</b> BIANCO / WHITE BLANC / BLANCO	<b>2U</b> GRIGIO POLVERE / POWDER GREY GRIS POUFRE / GRIS POLVO

(01 BIANCO abbinabile a anta A1 e 1V BIANCO ARTICO)  
(2U GRIGIO POLVERE abbinabile a anta F2 GRIGIO GRAFITE)

(01 WHITE matching A1 and 1V ARCTIC WHITE door)  
(2U POWDER GREY matching F2 GRAPHITE GREY door)

(01 BLANC assorti à la porte A1 et 1V BLANC ARCTIQUE)  
(2U GRIS POUFRE assorti à porte F2 GRIS GRAPHITE)

(01 BLANCO combinable con puerta A1 y 1V BIANCO ARTICO)  
(2U GRIS POLVO combinable con puerta F2 GRIS GRAFITO)

