

FRAME

Volassini
DESIGN

KELLY

Volassini
DESIGN



Anta sp.
Door th. / Façade Ép. / Puerta Esp.
22 mm

H. fusto mobili base
H. Base units carcasses / H. Caisson meubles bas / H. Casco muebles bajos
81 cm

Estraibili
Pull-out / Coulissant / Extraible
Legrabox
Ta'or

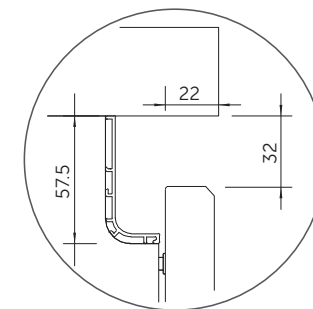
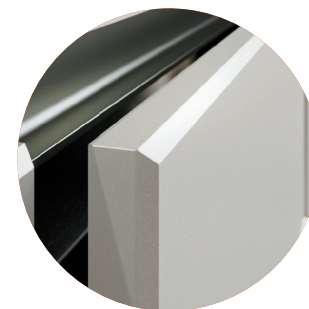

Profilo gola
Channel profile / Profils à gorge / Perfil gola

Colorazioni Fusti
Carcasses colours / Couleurs Caisson / Colores Casco



1W
Bianco Igloo
Igloo White
Blanc IGLÓO
Blanco IGLÚ



24
Grigio Monolite
Monolith Grey
Gris Monolithe
Gris Monolito



2R
Grigio Texture
Texture Grey
Gris Texture
Gris Texture



25
Grigio Status
Status Grey
Gris Status
Gris Status

FRAME-KELLY Finiture













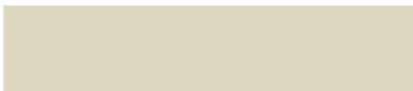
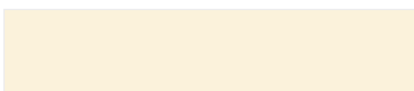

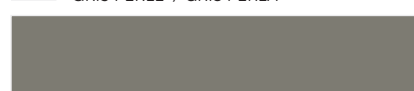
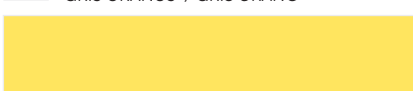
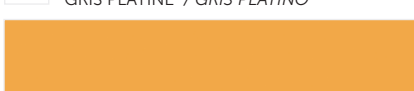









Finishes / Finitions / Acabados

LACCATI OPACHI

MATT LACQUERS / LAQUÉS MATS / LACADOS OPACOS

Colonna prezzo / Price column
Colonne prix / Columna precio

3

		
1V BIANCO ARTICO / ARCTIC WHITE BLANC ARCTIQUE / BLANCO ÁRTICO	0W BIANCO LUCE / REFLECT WHITE BLANC LUMIÈRE / BLANCO LUZ	2B GRIGIO PIUMA / FEATHER GREY GRIS PLUME / GRIS PLUMA
		
1A AVORIO / IVORY IVOIRE / MARFIL	20 GRIGIO PERLA / PEARL GREY GRIS PERLE / GRIS PERLA	2Q GRIGIO URANO / COSMIC GREY GRIS URANUS / GRIS URANO
		
2S GRIGIO PLATINO / PLATINUM GREY GRIS PLATINE / GRIS PLATINO	2A TITANIO / TITANIUM TITANE / TITANIO	7J GIALLO LEMON / LEMON YELLOW JAUNE CITRON / AMARILLO LEMON
		
73 GIALLO CURRY / CURRY YELLOW JAUNE CURRY / AMARILLO CURRY	D7 GIALLO SAHARA / SAHARA YELLOW JAUNE SAHARA / AMARILLO SAHARA	6N ARANCIO AUTUNNALE / AUTUMN ORANGE ORANGE AUTOMNE / NARANJA OTOÑAL
		
K3 ROSSO PECHINO / BEIJING RED ROUGE PÉKIN / ROJO PEKIN	31 ROSSO ITALIA / RACING RED ROUGE ITALIA / ROJO ITALIA	3N ROSSO GINGER / GINGER RED ROUGE GINGER / ROJO JENGIBRE
		
3E ROSSO MARSALA / MARSALA RED ROUGE MARSALA / ROJO MARSALA	C4 VERDE CEDRO / CEDAR GREEN VERT CÈDRE / VERDE CEDRO	4X TE' VERDE / TEA GREEN VERT THÉ / VERDE TÉ
		
4E VERDE FELCE / FERN GREEN VERT FOUGÈRE / VERDE HELECHO	F5 AZZURRO SVEZIA / SWEDEN BLUE BLEU SUÈDE / CELESTE SUECIA	5T BLU PATAGONIA / PATAGONIA BLUE BLEU PATAGONIE / AZUL PATAGONIA
		
5V BLU LAGO / LAKE BLUE BLEU LAC / AZUL LAGO	8A MARRONE FRUMENTO / WHEAT BROWN MARRON FROMENT / MARRÓN TRIGO	8V CAPPUCCINO / CAPPUCCINO CAPPUCCINO / CAPUCHINO
		
8H MARRONE CAFFÈ / COFFEE BROWN MARRON CAFÉ / MARRÓN CAFÉ	81 MARRONE TERRA / EARTH BROWN MARRON TERRE / MARRÓN TIERRA	9B NERO OMBRA / SHADOW BLACK NOIR OMBRE / NEGRO SOMBRA
		
F2 GRIGIO GRAFITE / GRAPHITE GREY GRIS GRAPHITE / GRIS GRAFITO	9G NERO / BLACK NOIR / NEGRO	

FRAME-KELLY Finiture

Finishes / Finitions / Acabados

LACCATI OPACHI TAILOR-MADE

MATT LACQUERS TAYLOR-MADE / LAQUÉS MATS SUR DEMANDE / LACADOS OPACOS TAILOR MADE

Colonna prezzo / Price column
Colonne prix / Columna precio

3+30%



TM TAILOR-MADE / TAILOR-MADE
SUR MESURE / PERSONALIZADO

Colore laccato opaco a richiesta con riferimento a: Cartella colori RAL, PANTONE (Formula guide) e NCS (Index 2)
Disponibile nella versione laccato opaco goffrato (soft) per i modelli che prevedono questa finitura
Prezzo (Retail): come laccato opaco + 30 %
Maggiorazione valida solamente per cucina completa in un unico colore RAL, PANTONE, NCS eventuali richieste che differiscano rispetto alle disposizioni sopra riportate devono essere approvate dalla Snaidero Rino Spa.
Tempi di consegna: aggiungere 4 settimane ai normali tempi di consegna
N.B. Non sono previsti completamenti nel tempo e non si accettano contestazioni sulla interpretazione del colore.
Possono esserci piccole differenze tra il riferimento Cartella colori ed il risultato finale.

Matt lacquer finish on request, providing reference to: RAL colour chart, PANTONE (Formula guide) and NCS (Index 2)
Soft matt lacquered version available for models which include this finish

Price (Retail): matt lacquer price + 30 %

Up-charge is valid only for complete kitchen in a single RAL, PANTONE or NCS colour any requests which differ to the provisions above must be approved by Snaidero Rino Spa.

Delivery time: add 4 working weeks to the standard schedule

N.B.: Following miscellaneous and additional orders are not available, objections about the colour interpretation will not be accepted.

There may be slight differences between the Colour chart and the final product.

Couleur laquée mate sur demande en référence à: Nuancier RAL, PANTONE (Formule guides) et NCS (Index 2)

Disponible en version laquée mate gaufrée (soft) pour les modèles offrant cette finition

Prix (Retail): comme laqué mat + 30 %

Supplément de prix valable uniquement pour une cuisine complète réalisée dans une seule couleur RAL, PANTONE, NCS; les éventuelles demandes qui diffèrent des dispositions ci-dessus évoquées doivent être validées par Snaidero Rino Spa.

Délais de livraison: veuillez ajouter 4 semaines aux délais de livraison normaux

N.B. Tout ajout et complément de commande dans le temps, ou bien litige concernant l'interprétation de la couleur ne sera pas accepté.

Il peut y avoir de petites différences entre le nuancier de référence et le résultat final.

Color lacado opaco a pedido con alusión a: Carpeta colores RAL, PANTON (Formula guía) y NCS (Index 2)

Disponible en la versión lacado opaco estampado (soft) para los modelos que preveen esta terminación

Precio (Retail): como el lacado mate + 30%

Incremento válido solamente para cocina completa en un único color RAL, PANTON, NCS eventuales solicitudes que difieran respecto a las disposiciones informadas

Tiempos de entrega: agregar 4 semanas a los tiempos normales de entrega.

N.B. No están previstos cumplimientos en el tiempo y no se aceptan reclamos sobre la interpretación del color.











Pueden existir pequeñas diferencias entre la referencia Carpeta de colores y el resultado final

LACCATI MICALIZZATI

MICALISED LACQUERS / LAQUÉS MICALISÉS / LACADOS MICALIZADOS

Colonna prezzo / Price column
Colonne prix / Columna precio

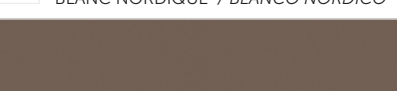
5

		
HC ARGENTO / SILVER ARGENT / PLATA	51 NIGHT BLUE / NIGHT BLUE NIGHT BLUE / NIGHT BLUE	4S VERDE ALPI / ALPI GREEN VERT ALPI / VERDE ALPES
		
43 VERDE GREY / GREY GREEN VERT GREY / VERDE GREY	77 SABBIA MARINA / MARINE SAND SABLE MARIN / ARENA MARINA	1K BIANCO NORDIC / NORDIC WHITE BLANC NORDIQUE / BLANCO NÓRDICO
		
2E GRIGIO CEMENTO / CEMENT GREY GRIS CIMENT / GRIS CEMENTO	29 GRIGIO PIOMBO / LEAD GREY GRIS PLOMB / GRIS PLOMO	HU ORO BRUNITO / BURNISHED GOLD OR BRUNI / ORO BRUÑIDO
		
9E NERO EXTRA / EXTRA BLACK NOIR EXTRA / NEGRO EXTRA		

Attenzione: in caso di sostituzioni o completamenti a causa del ciclo particolare di verniciatura, leggere differenze di tono/effetto non sono da potersi considerare difetti ma caratteristiche intrinseche del prodotto.

Attention: please note that due to specific paint cycle, slight variations in the tone/ effect, occurring in case of remedials or additional parts, shall not be viewed as defects but intrinsic peculiarities of product.

Attention: en raison du cycle de peinture spécifique, en cas de remplacements ou éléments supplémentaires, des légères variations de tonalité/effet ne sont pas des défauts mais des caractéristiques intrinsèques du produit.

Atención: en caso de reemplazos o pedidos adicionales, debido al ciclo de aplicacion de laca, las pequeñas deferencias en el tono/efecto no deben considerarse defectos sino características intrínsecas del producto

FRAME-KELLY Finiture

Finishes / Finitions / Acabados

LACCATI OPACHI SUPER MATT

MATT LACQUERS SUPER-MATT / LAQUÉS MATS SUPER-MATT / LACADOS MATE SUPER-MATT

Colonna prezzo / Price column
Colonne prix / Columna precio

5



9R **NERO PURO** / PURE BLACK
NOIR PURE / NEGRO PURO

LACCATI LUCIDI

HIGH GLOSS LACQUERS / LAQUÉS BRILLANTS / LACADOS BRILLOS

Colonna prezzo / Price column
Colonne prix / Columna precio

10



15 **BIANCO 288** / WHITE 288
BLANC 288 / BLANCO 288

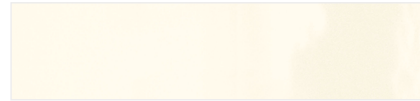

12 **BIANCO MAJESTIC** / MAJESTIC WHITE
BLANC MAJESTIC / BLANCO MAJESTIC

FRAME-KELLY Profili gola

Channel profiles / Profils à gorge / Perfil gola

ALLUMINIO ANODIZZATO

ANODIZED ALUMINUM / ALUMINIUM ANODISÉ / ALUMINIO ANODIZADO



HX **ACCIAIO INOX** / STAINLESS STEEL
ACIER INOX / ACERO INOXIDABLE



H7 **TITANIO** / TITANIUM
TITANE / TITANIO



90 **NERO** / BLACK
NOIR / NEGRO

ALLUMINIO VERNICIATO A POLVERI

POWDER-COATED ALUMINUM / ALUMINIUM LAQUÉ POUFRE / ALUMINIO BARNIZADO CON POLVO



01 **BIANCO** / WHITE
BLANC / BLANCO



2U **GRIGIO POLVERE** / POWDER GREY
GRIS POUFRE / GRIS POLVO

(01 BIANCO abbinabile a anta 1V BIANCO ARTICO)
(2U GRIGIO POLVERE abbinabile a anta F2 GRIGIO GRAFITE)
(01 WHITE matching 1V ARCTIC WHITE door)
(2U POWDER GREY matching F2 GRAPHITE GREY door)
(01 BLANC assorti à la porte 1V BLANC ARCTIQUE)
(2U GRIS POUFRE assorti à porte F2 GRIS GRAPHITE)
(01 BLANCO combinable con puerta 1V BLANCO ARTICO)
(2U GRIS POLVO combinable con puerta F2 GRIS GRAFITO)

