

WAY

SNAIDERO
DESIGN

WAY
MATERIA

SNAIDERO
DESIGN





Anta sp.
Door th. / Façade Ép. / Puerta Esp.
22 mm

H. fusto mobili base
H. Base units carcasses / H. Caisson meubles bas / H. Casco muebles bajos
81 cm

Estraibili
Pull-out / Coulissant / Extraible
Antaro
Legrabox
Ta'or

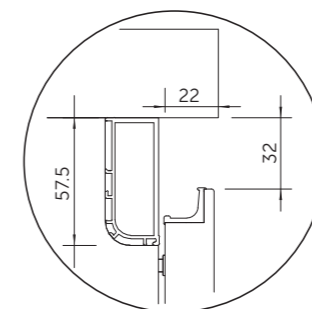

Profilo gola piatta
Flat-channel profiles / Profils à gorge plane / Perfil gola plana

Colorazioni Fusti
Carcasses colours / Couleurs Caisson / Colores Casco



1W
Bianco Igloo
Igloo White
Blanc IGLOO
Blanco IGLÚ



24
Grigio Monolite
Monolith Grey
Gris Monolithe
Gris Monolito



2R
Grigio Texture
Texture Grey
Gris Texture
Gris Texture



25
Grigio Status
Status Grey
Gris Status
Gris Status

WAY Finiture

Finishes / Finitions / Acabados

TECH COLOR ABS (*LASER)

TECH COLOR ABS (*LASER) / TECH COLOR ABS (*LASER) / TECH COLOR ABS (*LASER)

Colonna prezzo / Price column
Colonne prix / Columna precio

1

		
A1 BIANCO ARTICO / ARCTIC WHITE BLANC ARCTIQUE / BLANCO ÁRTICO	G2 GRIGIO PIUMA / FEATHER GREY GRIS PLUME / GRIS PLUMA	J2 CAPPUCCINO / CAPPUCCINO CAPPUCCINO / CAPUCHINO
		
1B BIANCO LIPARI * / LIPARI WHITE * BLANC LIPARI * / BLANCO LIPARI *	2P GRIGIO VULCANO * / VULCANO * GREY GRIS VULCANO * / GRIS VOLCÁN *	2Y GRIGIO TREMITI * / TREMITI * GREY GRIS TREMITI * / GRIS TREMITI *
		
Y2 GRIGIO ETNA * / ETNA GREY * GRIS ETNA * / GRIS ETNA *	9Q NERO STROMBOLI * / STROMBOLI BLACK * NOIR STROMBOLI * / NEGRO STROMBOLI *	

TECH MATERIC BORDI ABS (*LASER)

TECH MATERIC ABS EDGES (*LASER) / TECH MATERIC CHANTS ABS (*LASER) / TECH MATERIC BORDES ABS (*LASER)

Colonna prezzo / Price column
Colonne prix / Columna precio

1

		
RC ROVERE COPENAGHEN / COPENAGHEN OAK CHÈNE COPENHAGUE / ROBLE COPENHAGUE	RM ROVERE CANYON / CANYON OAK CHÈNE CANYON / ROBLE CANYON	FO FRASSINO NOIR * / ASH NOIR * FRÈNE NOIR * / FRESNO NEGRO *
		
NO NOCE ITALIA / ITALIA WALNUT NOYER ITALIA / NOGAL ITALIA	B2 RESINA CENERE / ASH RESIN RÉSINE CENDRES / RESINA CENIZA	HR BRONZO COLATO * / CAST BRONZE * BRONZE COULÉ * / BRONCE FUNDIDO *
		
HT GRIGIO TEMPRA * / TEMPRA * GREY GRIS TEMPRA * / GRIS TEMPLE *	JN BOTTICINO ARTSTONE * / BOTTICINO ARTSTONE * BOTTICINO ARTSTONE * / BOTTICINO ARTSTONE *	J1 PATAGONIA ARTSTONE * / PATAGONIA ARTSTONE * PATAGONIA ARTSTONE * / PATAGONIA ARTSTONE *
		
WE EUCALIPTO FENICE / FENICE EUCALYPTUS EUCALYPTUS FENICE / EUCALIPTO FENIX	YL OLMO LAGUNA / LAGUNA ELM ORME LAGUNE / OLMO LAGUNA	S2 ROVERE LIDO * / LIDO OAK * CHÈNE LIDO * / ROBLE LIDO *
		
H9 RESINA CALLE * / CALLE RESIN * RÉSINE CALLE * / RESINA CALLE *	9V RESINA GIUDECCA * / GIUDECCA RESIN * RÉSINE GIUDECCA * / RESINA GIUDECCA *	

N.B.: Ante, facciate e pannelli effetto legno, qualora adiacenti, non vengono forniti in continuità di vena

N.B.: Bookmatching is not provided for doors, fronts and panels in wood-effect, if adjacent.

N.B.: Portes, façades et panneaux effet bois ne sont pas fournis avec veinage continu lorsqu'adjacents

NOTA: Las puertas, los frentes y los paneles con efecto madera, si son adyacentes, no se suministran con continuidad de veta

WAY Finiture







Finishes / Finitions / Acabados

TECH SENSE OPACHI BORDI ABS (*LASER)

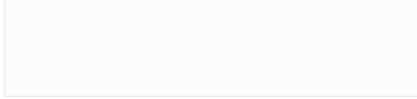
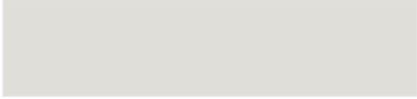
TECH SENSE MATT ABS EDGES (*LASER) / TECH SENSE OPAQUES CHANTS ABS (*LASER) / TECH SENSE MATE BORDES ABS (*LASER)

Colonna prezzo / Price column
Colonne prix / Columna precio

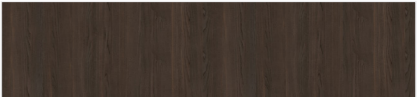
2

		
1Y BIANCO GELSOMINO * / JASMINE WHITE * BLANC JASMIN * / BLANCO JAZMÍN *	A2 GRIGIO CASHMERE * / CASHMERE GREY * GRIS CASHMERE * / GRIS CACHEMIRA *	K2 GRIGIO INCENSO * / INCENSE GREY * GRIS ENCENS * / GRIS INCIENSO *
		
3Z GRIGIO PEPE * / PEPPER GREY * GRIS POIVRE * / GRIS PIMIENTA *	9Y NERO VELLUTO * / VELVET BLACK * NOIR VELOUR * / NEGRO TERCIOPELO *	FJ FRASSINO ANICE * / ANICE ASH * FRÈNE ANIS * / FRESNO ANIS *
		
FU FRASSINO SAMARCANDA * / SAMARCANDA ASH * FRÈNE SAMARCANDA * / FRESNO SAMARCANDA *		

N.B.: Ante, facciate e pannelli effetto legno, qualora adiacenti, non vengono forniti in continuità di vena
Non disponible per ante > 220,6

N.B.: Bookmatching is not provided for doors, fronts and panels in wood-effect, if adjacent.
Not available for doors > 220,6

N.B.: Portes, façades et panneaux effet bois ne sont pas fournis avec veinage continu lorsqu'adjacents
Pas disponibles pour portes > 220,6

NOTA: Las puertas, los frentes y los paneles con efecto madera, si son adyacentes, no se suministran con continuidad de veta
No disponible para puertas > 220,6

WAY Finiture

Finishes / Finitions / Acabados

LACCATI OPACHI

MATT LACQUERS / LAQUÉS MATS / LACADOS OPACOS

Colonna prezzo / Price column
Colonne prix / Columna precio

3

1V BIANCO ARTICO / ARCTIC WHITE BLANC ARCTIQUE / BLANCO ÁRTICO	0W BIANCO LUCE / REFLECT WHITE BLANC LUMIÈRE / BLANCO LUZ	2B GRIGIO PIUMA / FEATHER GREY GRIS PLUME / GRIS PLUMA
1A AVORIO / IVORY IVOIRE / MARFIL	20 GRIGIO PERLA / PEARL GREY GRIS PERLE / GRIS PERLA	2Q GRIGIO URANO / COSMIC GREY GRIS URANUS / GRIS URANO
2S GRIGIO PLATINO / PLATINUM GREY GRIS PLATINE / GRIS PLATINO	2A TITANIO / TITANIUM TITANE / TITANIO	7J GIALLO LEMON / LEMON YELLOW JAUNE CITRON / AMARILLO LEMON
73 GIALLO CURRY / CURRY YELLOW JAUNE CURRY / AMARILLO CURRY	D7 GIALLO SAHARA / SAHARA YELLOW JAUNE SAHARA / AMARILLO SAHARA	6N ARANCIO AUTUNNALE / AUTUMN ORANGE ORANGE AUTOMNE / NARANJA OTOÑAL
K3 ROSSO PECHINO / BEIJING RED ROUGE PÉKIN / ROJO PEKIN	31 ROSSO ITALIA / RACING RED ROUGE ITALIA / ROJO ITALIA	3N ROSSO GINGER / GINGER RED ROUGE GINGER / ROJO JENGIBRE
3E ROSSO MARSALA / MARSALA RED ROUGE MARSALA / ROJO MARSALA	C4 VERDE CEDRO / CEDAR GREEN VERT CÈDRE / VERDE CEDRO	4X TE' VERDE / TEA GREEN VERT THÉ / VERDE TÉ
4E VERDE FELCE / FERN GREEN VERT FOUGÈRE / VERDE HELECHO	F5 AZZURRO SVEZIA / SWEDEN BLUE BLEU SUÈDE / CELESTE SUECIA	5T BLU PATAGONIA / PATAGONIA BLUE BLEU PATAGONIE / AZUL PATAGONIA
5V BLU LAGO / LAKE BLUE BLEU LAC / AZUL LAGO	8A MARRONE FRUMENTO / WHEAT BROWN MARRON FROMENT / MARRÓN TRIGO	8V CAPPUCCINO / CAPPUCCINO CAPPUCCINO / CAPUCHINO
8H MARRONE CAFFÈ / COFFEE BROWN MARRON CAFÉ / MARRÓN CAFÉ	81 MARRONE TERRA / EARTH BROWN MARRON TERRE / MARRÓN TIERRA	9B NERO OMBRA / SHADOW BLACK NOIR OMBRE / NEGRO SOMBRA
F2 GRIGIO GRAFITE / GRAPHITE GREY GRIS GRAPHITE / GRIS GRAFITO	9G NERO / BLACK NOIR / NEGRO	

WAY Finiture

Finishes / Finitions / Acabados

LACCATI OPACHI TAILOR-MADE

MATT LACQUERS TAYLOR-MADE / LAQUÉS MATS SUR DEMANDE / LACADOS OPACOS TAILOR MADE

Colonna prezzo / Price column
Colonne prix / Columna precio

3+30%



TM TAILOR-MADE / TAILOR-MADE
SUR MESURE / PERSONALIZADO

Colore laccato opaco a richiesta con riferimento a: Cartella colori RAL, PANTONE (Formula guide) e NCS (Index 2)
Disponibile nella versione laccato opaco goffrato (soft) per i modelli che prevedono questa finitura
Prezzo (Retail): come laccato opaco + 30 %
Maggiorazione valida solamente per cucina completa in un unico colore RAL, PANTONE, NCS eventuali richieste che differiscano rispetto alle disposizioni sopra riportate devono essere approvate dalla Snaidero Rino Spa.
Tempi di consegna: aggiungere 4 settimane ai normali tempi di consegna
N.B. Non sono previsti completamenti nel tempo e non si accettano contestazioni sulla interpretazione del colore.
Possono esserci piccole differenze tra il riferimento Cartella colori ed il risultato finale.

Matt lacquer finish on request, providing reference to: RAL colour chart, PANTONE (Formula guide) and NCS (Index 2)

Soft matt lacquered version available for models which include this finish

Price (Retail): matt lacquer price + 30 %

Up-charge is valid only for complete kitchen in a single RAL, PANTONE or NCS colour any requests which differ to the provisions above must be approved by Snaidero Rino Spa.

Delivery time: add 4 working weeks to the standard schedule

N.B.: Following miscellaneous and additional orders are not available, objections about the colour interpretation will not be accepted.

There may be slight differences between the Colour chart and the final product.

Couleur laquée mate sur demande en référence à : Nuancier RAL, PANTONE (Formule guides) et NCS (Index 2)

Disponible en version laquée mate gaufrée (soft) pour les modèles offrant cette finition

Prix (Retail): comme laqué mat + 30 %

Supplément de prix valable uniquement pour une cuisine complète réalisée dans une seule couleur RAL, PANTONE, NCS; les éventuelles demandes qui diffèrent des dispositions ci-dessus évoquées doivent être validées par Snaidero Rino Spa.

Délais de livraison : veuillez ajouter 4 semaines aux délais de livraison normaux

N.B. Tout ajout et complément de commande dans le temps, ou bien litige concernant l'interprétation de la couleur ne sera pas accepté.

Il peut y avoir de petites différences entre le nuancier de référence et le résultat final.

Color lacado opaco a pedido con alusión a: Carpeta colores RAL, PANTON (Formula guía) y NCS (Index 2)

Disponible en la versión lacado opaco estampado (soft) para los modelos que preveen esta terminación

Precio (Retail): como el lacado mate + 30%

Incremento válido solamente para cocina completa en un único color RAL, PANTON, NCS eventuales solicitudes que difieran respecto a las disposiciones informadas

Tiempos de entrega: agregar 4 semanas a los tiempos normales de entrega.

N.B. No están previstos cumplimientos en el tiempo y no se aceptan reclamos sobre la interpretación del color.

Pueden existir pequeñas diferencias entre la referencia Carpeta de colores y el resultado final

FENIX BORDI ABS

FENIX WITH ABS EDGES / FENIX CHANTS ABS / FENIX CANTOS ABS

Colonna prezzo / Price column
Colonne prix / Columna precio

4

16 BIANCO KOS / KOS WHITE BLANC KOS / BLANCO KOS	14 BIANCO ALASKA / ALASKA WHITE BLANC ALASKA / BLANCO ALASKA	F8 BEIGE COLOSTRAI / COLOSTRAI BEIGE BEIGE COLOSTRAI / BEIGE COLOSTRAI
8Q BEIGE ARIZONA / ARIZONA BEIGE BEIGE ARIZONA / BEIGE ARIZONA	27 GRIGIO LONDRA / LONDON GREY GRIS LONDRES / GRIS LONDRES	2W GRIGIO STROMBOLI / STROMBOLI GREY GRIS STROMBOLI / GRIS STROMBOLI
9N NERO INGO / INGO BLACK NOIR INGO / NEGRO INGO	3B ROSSO JAIPUR / JAIPUR RED ROUGE JAIPUR / ROJO JAIPUR	D4 VERDE COMODORO / COMODORO GREEN VERT COMODORO / VERDE COMODORO

MONOLACCATI LUCIDI

HIGH GLOSS MONOLACQUERS / MONOLAQUÉS BRILLANTS / MONOLACADOS BRILLOS

Colonna prezzo / Price column
Colonne prix / Columna precio

4

1V BIANCO ARTICO / ARCTIC WHITE BLANC ARCTIQUE / BLANCO ÁRTICO	2B GRIGIO PIUMA / FEATHER GREY GRIS PLUME / GRIS PLUMA

Non disponibile per ante > 220,6

Not available for doors > 220,6

Pas disponibles pour portes > 220,6

No disponible para puertas > 220,6

WAY Finiture

Finishes / Finitions / Acabados

LACCATI LUCIDI

HIGH GLOSS LACQUERS / LAQUÉS BRILLANTS / LACADOS BRILLOS

Colonna prezzo / Price column
Colonne prix / Columna precio

5

	0W BIANCO LUCE / REFLECT WHITE BLANC LUMIÈRE / BLANCO LUZ		1A AVORIO / IVORY IVOIRE / MARFIL		20 GRIGIO PERLA / PEARL GREY GRIS PERLE / GRIS PERLA
	2Q GRIGIO URANO / COSMIC GREY GRIS URANUS / GRIS URANO		2S GRIGIO PLATINO / PLATINUM GREY GRIS PLATINE / GRIS PLATINO		2A TITANIO / TITANIUM TITANE / TITANIO
	7J GIALLO LEMON / LEMON YELLOW JAUNE CITRON / AMARILLO LEMON		73 GIALLO CURRY / CURRY YELLOW JAUNE CURRY / AMARILLO CURRY		D7 GIALLO SAHARA / SAHARA YELLOW JAUNE SAHARA / AMARILLO SAHARA
	6N ARANCIO AUTUNNALE / AUTUMN ORANGE ORANGE AUTOMNE / NARANJA OTOÑAL		K3 ROSSO PECHINO / BEIJING RED ROUGE PÉKIN / ROJO PEKÍN		31 ROSSO ITALIA / RACING RED ROUGE ITALIA / ROJO ITALIA
	3N ROSSO GINGER / GINGER RED ROUGE GINGER / ROJO JENGIBRE		3E ROSSO MARSALA / MARSALA RED ROUGE MARSALA / ROJO MARSALA		C4 VERDE CEDRO / CEDAR GREEN VERT CÉDRE / VERDE CEDRO
	4X TÉ VERDE / TEA GREEN VERT THÉ / VERDE TÉ		4E VERDE FELCE / FERN GREEN VERT FOUGÈRE / VERDE HELECHO		F5 AZZURRO SVEZIA / SWEDEN BLUE BLEU SUÈDE / CELESTE SUECIA
	5T BLU PATAGONIA / PATAGONIA BLUE BLEU PATAGONIE / AZUL PATAGONIA		5V BLU LAGO / LAKE BLUE BLEU LAC / AZUL LAGO		8A MARRONE FRUMENTO / WHEAT BROWN MARRON FROMENT / MARRÓN TRIGO
	8V CAPPUCCINO / CAPPUCCINO CAPPUCCINO / CAPUCHINO		8H MARRONE CAFFÉ / COFFEE BROWN MARRON CAFÉ / MARRÓN CAFÉ		81 MARRONE TERRA / EARTH BROWN MARRON TERRE / MARRÓN TIERRA
	9B NERO OMBRA / SHADOW BLACK NOIR OMBRE / NEGRO SOMBRA		F2 GRIGIO GRAFITE / GRAPHITE GREY GRIS GRAPHITE / GRIS GRAFITO		9G NERO / BLACK NOIR / NEGRO

WAY Finiture

Finishes / Finitions / Acabados

LACCATI LUCIDI TAILOR-MADE

HIGH GLOSS LACQUERS TAYLOR-MADE / LAQUÉS BRILLANTS SUR DEMANDE / LACADOS BRILLOS TAILOR MADE

Colonna prezzo / Price column
Colonne prix / Columna precio

5+30%

TM TAILOR-MADE / TAILOR-MADE
SUR MESURE / PERSONALIZADO

Colore laccato lucido a richiesta con riferimento a: Cartella colori RAL, PANTONE (Formula guide) e NCS (Index 2)
Disponibile nella versione laccato lucido per i modelli che prevedono questa finitura
Prezzo (Retail): come laccato lucido + 30 %
Maggiorazione valida solamente per cucina completa in un unico colore RAL, PANTONE, NCS eventuali richieste che differiscano rispetto alle disposizioni sopra riportate devono essere approvate dalla Snaidero Rino Spa.
Tempi di consegna: aggiungere 4 settimane ai normali tempi di consegna
N.B. Non sono previsti completamenti nel tempo e non si accettano contestazioni sulla interpretazione del colore.
Possono esserci piccole differenze tra il riferimento Cartella colori ed il risultato finale.

Gloss lacquer finish on request, providing reference to: RAL colour chart, PANTONE (Formula guide) and NCS (Index 2)
Gloss lacquered version available for models which include this finish
Price (Retail): high gloss lacquer price + 30 %
Up-charge is valid only for complete kitchen in a single RAL, PANTONE or NCS colour any requests which differ to the provisions above must be approved by Snaidero Rino Spa.
Delivery time: add 4 working weeks to the standard schedule
N.B.: Following miscellaneous and additional orders are not available, objections about the colour interpretation will not be accepted.
There may be slight differences between the Colour chart and the final product.

Color laccato brillante sur demande en référence à : Nuancier RAL, PANTONE (Formule guides) et NCS (Index 2)
Disponibile en version laquée brillante pour les modèles offrant finition
Prix (Retail): comme laqué brillant + 30 %
Supplément de prix valable uniquement pour une cuisine complète réalisée dans une seule couleur RAL, PANTONE, NCS; les éventuelles demandes qui diffèrent des dispositions ci-dessus évoquées doivent être validées par Snaidero Rino Spa.
Délais de livraison : veuillez ajouter 4 semaines aux délais de livraison normaux
N.B. Tout ajout et complément de commande dans le temps, ou bien litige concernant l'interprétation de la couleur ne sera pas accepté.
Il peut y avoir de petites différences entre le nuancier de référence et le résultat final.

Color laccado brillante bajo pedido con referencia a: Carpeta colores RAL, PANTONE (Fórmula guías) y NCS (Index 2)
Disponibile en la versión lacado brillante para los modelos que prevén este acabado
Precio (Retail): como el lacado brillo + 30%
Incremento válido solamente para cocina completa en un unico color RAL, PANTON, NCS eventuales solicitudes que difieran respecto a las disposiciones informadas precedentemente deben ser aprobadas por Snaidero Rino Spa.
Tiempos de entrega: agregar 4 semanas a los tiempos normales de entrega.
N.B. No están previstos cumplimientos en el tiempo y no se aceptan reclamos sobre la interpretación del color.
Pueden existir pequeñas diferencias entre la referencia Carpeta de colores y el resultado final

LACCATI MICALIZZATI

MICALISED LACQUERS / LAQUÉS MICALISÉS / LACADOS MICALIZADOS

Colonna prezzo / Price column
Colonne prix / Columna precio

5

	HC ARGENTO / SILVER ARGENT / PLATA		51 NIGHT BLUE / NIGHT BLUE NIGHT BLUE / NIGHT BLUE		4S VERDE ALPI / ALPI GREEN VERT ALPI / VERDE ALPES
	43 VERDE GREY / GREY GREEN VERT GREY / VERDE GREY		77 SABBIA MARINA / MARINE SAND SABLE MARIN / ARENA MARINA		1K BIANCO NORDIC / NORDIC WHITE BLANC NORDIQUE / BLANCO NÓRDICO
	72 CHAMPAGNE / CHAMPAGNE CHAMPAGNE / CHAMPÁN		2E GRIGIO CEMENTO / CEMENT GREY GRIS CIMENT / GRIS CEMENTO		29 GRIGIO PIOMBO / LEAD GREY GRIS PLOMB / GRIS PLOMO
	HU ORO BRUNITO / BURNISHED GOLD OR BRUNI / ORO BRUÑIDO		9E NERO EXTRA / EXTRA BLACK NOIR EXTRA / NEGRO EXTRA		

Attenzione: in caso di sostituzioni o completamenti a causa del ciclo particolare di verniciatura, leggere differenze di tono/effetto non sono da potersi considerare difetti ma caratteristiche intrinseche del prodotto.
Attention: please note that due to specific paint cycle, slight variations in the tone/effct, occurring in case of remedials or additional parts, shall not be viewed as defects but intrinsic peculiarities of product.
Attention: en raison du cycle de peinture spécifique, en cas de remplacements ou éléments supplémentaires, des légères variations de tonalité/effet ne sont pas des défauts mais des caractéristiques intrinsèques du produit.
Atención: en caso de reemplazos o pedidos adicionales, debido al ciclo de aplicacion de laca, las pequeñas deferencias en el tono/efecto no deben considerarse defectos sino características intrínsecas del producto

WAY Finiture

Finishes / Finitions / Acabados

LACCATI OPACHI SUPER MATT

MATT LACQUERS SUPER-MATT / LAQUÉS MATS SUPER-MATT / LACADOS MATE SUPER-MATT

Colonna prezzo / Price column
Colonne prix / Columna precio

5



9R **NERO PURO** / PURE BLACK
NOIR PURE / NEGRO PURO

LACCATI METALLIZZATI LUCIDI

HIGH GLOSS METALLIZED LACQUERS / LAQUÉS MÉTALLISÉS BRILLANTS / LACADOS METALIZADOS BRILLOS

Colonna prezzo / Price column
Colonne prix / Columna precio

7



HC **ARGENTO** / SILVER
ARGENT / PLATA



51 **NIGHT BLUE** / NIGHT BLUE
NIGHT BLUE / NIGHT BLUE



4S **VERDE ALPI** / ALPI GREEN
VERT ALPI / VERDE ALPES

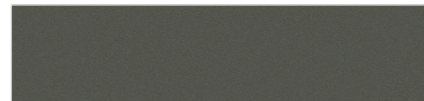

43 **VERDE GREY** / GREY GREEN
VERT GREY / VERDE GREY

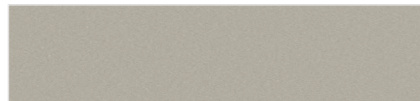

77 **SABBIA MARINA** / MARINE SAND
SABLE MARIN / ARENA MARINA

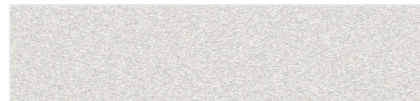

1K **BIANCO NORDIC** / NORDIC WHITE
BLANC NORDIQUE / BLANCO NORDICO

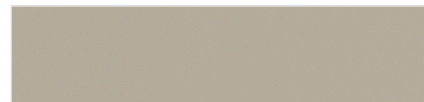

72 **CHAMPAGNE** / CHAMPAGNE
CHAMPAGNE / CHAMPÁN

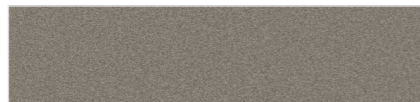

2E **GRIGIO CEMENTO** / CEMENT GREY
GRIS CIMENT / GRIS CEMENTO



29 **GRIGIO PIOMBO** / LEAD GREY
GRIS PLOMB / GRIS PLOMO



HU **ORO BRUNITO** / BURNISHED GOLD
OR BRUNI / ORO BRUNIDO



9E **NERO EXTRA** / EXTRA BLACK
NOIR EXTRA / NEGRO EXTRA

Attenzione: in caso di sostituzioni o completamenti a causa del ciclo particolare di verniciatura, leggere differenze di tono/effetto non sono da potersi considerare difetti ma caratteristiche intrinseche del prodotto.

Attention: please note that due to specific paint cycle, slight variations in the tone/effect, occurring in case of remedials or additional parts, shall not be viewed as defects but intrinsic peculiarities of product.

Attention: en raison du cycle de peinture spécifique, en cas de remplacements ou éléments supplémentaires, des légères variations de tonalité/effet ne sont pas des défauts mais des caractéristiques intrinsèques du produit.

Atención: en caso de reemplazos o pedidos adicionales, debido al ciclo de aplicacion de laca, las pequeñas deferencias en el tono/efecto no deben considerarse defectos sino características intrinsecas del producto

IMPIALLACCIATI LEGNO

WOOD VENEER / PLAQUÉS BOIS / ENCHAPADOS MADERA

Colonna prezzo / Price column
Colonne prix / Columna precio

7



G2 **ROVERE CARBONE** / COAL OAK
CHÈNE CHARBON / ROBLE CARBÓN

Attenzione: a causa della natura del materiale, leggere differenze di tono/effetto non sono da potersi considerare difetti ma caratteristiche intrinseche del prodotto. Ante, facciate e pannelli impiallacciati legno, qualora adiacenti, non vengono forniti in continuità di vena

Attention: please note that due to the nature, slight variations in the tone/effect shall not be viewed as defects but intrinsic peculiarities of product. Doors, fronts and wood veneered panels, if adjacent, are not provided with continuity of vein

Attention: en raison de la nature de la matière, des légères variations de tonalité/effet ne sont pas des défauts mais des caractéristiques intrinsèques du produit. Portes, façades et panneaux plaqués bois, non fournis avec veinage continu lorsqu'adjacents.

Atención: debido a la naturaleza del material, las pequeñas deferencias en el tono/efecto no deben considerarse defectos, sino características intrinsecas del producto Las puertas, los frentes y los paneles enchapados de madera, si son adyacentes, no se suministran con continuidad de vena

WAY Finiture

Finishes / Finitions / Acabados

IMPIALLACCIATI LEGNO

WOOD VENEER / PLAQUÉS BOIS / ENCHAPADOS MADERA

Colonna prezzo / Price column
Colonne prix / Columna precio

8

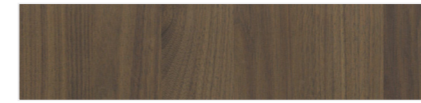

N6 **NOCE AMERICANO** / AMERICAN WALNUT
NOYER AMÉRICAIN / NOGAL AMERICANO



EK **ROVERE CENERE** / ASH OAK
CHÈNE CENDRES / ROBLE CENIZA



EL **ROVERE DOLOMITI** / DOLOMITI OAK
CHÈNE DOLOMITI / ROBLE DOLOMITAS



ST **ROVERE SPACCO** / RIFT-CUT OAK
CHÈNE SPACCO / ROBLE SPACCO

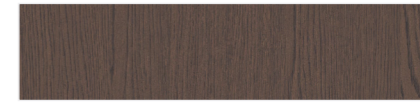

SV **ROVERE TERRA** / EARTH OAK
CHÈNE TERRE / ROBLE TERRA



NF **NOCE EUROPEO** / EUROPEAN WALNUT
NOYER EUROPÉEN / NOGAL EUROPEO



WA **EUCALIPTO SABBIAATO AFUMICATO** / SANDBLASTED SMOKED EUCALYPTUS
EUCALYPTUS FUMÉ SABLÉ / EUCALIPTO HUMO ARENADO

Attenzione: a causa della natura del materiale, leggere differenze di tono/effetto non sono da potersi considerare difetti ma caratteristiche intrinseche del prodotto. Ante, facciate e pannelli impiallacciati legno, qualora adiacenti, non vengono forniti in continuità di vena

Attention: please note that due to the nature, slight variations in the tone/effect shall not be viewed as defects but intrinsic peculiarities of product. Doors, fronts and wood veneered panels, if adjacent, are not provided with continuity of vein

Attention: en raison de la nature de la matière, des légères variations de tonalité/effet ne sont pas des défauts mais des caractéristiques intrinsèques du produit. Portes, façades et panneaux plaqués bois, non fournis avec veinage continu lorsqu'adjacents.

Atención: debido a la naturaleza del material, las pequeñas deferencias en el tono/efecto no deben considerarse defectos, sino características intrinsecas del producto Las puertas, los frentes y los paneles enchapados de madera, si son adyacentes, no se suministran con continuidad de vena

IMPIALLACCIATI LEGNO

WOOD VENEER / PLAQUÉS BOIS / ENCHAPADOS MADERA

Colonna prezzo / Price column
Colonne prix / Columna precio

9



CF **CASTAGNO BASALTO PIALLATO** / PLANED BASALT CHESTNUT
CHÂTAIGNIER BASALTE RABOTÉ / CASTAÑO CEPILLADO COLOR BASALTO

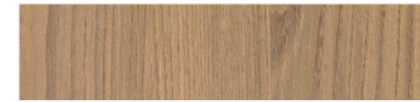

CY **CASTAGNO VAPORE PIALLATO** / PLANED STEAM CHESTNUT
CHÂTAIGNIER VAPEUR RABOTÉ / CASTAÑO VAPORIZADO Y CEPILLADO



WH **EUCALIPTO OSSIDATO** / OXIDISED EUCALYPTUS
EUCALYPTUS OXYDE / EUCALIPTO OXIDADO



N7 **NOCE MICRODOGATO** / MICRO-SLATTED WALNUT
NOYER MICRO-LAMÉ / NOGAL MICROFRESADO



SU **ROVERE SPACCO GRIGIO** / GREY RIFT-CUT OAK
CHÈNE SPACCO GRIS / ROBLE SPACCO GRIS

Attenzione: a causa della natura del materiale, leggere differenze di tono/effetto non sono da potersi considerare difetti ma caratteristiche intrinseche del prodotto. N.B.: Ante, facciate e pannelli impiallacciati legno, qualora adiacenti, non vengono forniti in continuità di vena fatta eccezione per le finiture WD Eucalipto Affumicato Frisée Satinato e Lucido

Attention: please note that due to the nature, slight variations in the tone/effect shall not be viewed as defects but intrinsic peculiarities of product.

NOTE: Doors, fronts and wood veneered panels, if adjacent, are not supplied in continuity of vein except for the Satin and Glossy Smoked Eucalyptus Frisée WD finishes.

Attention: en raison de la nature de la matière, des légères variations de tonalité/effet ne sont pas des défauts mais des caractéristiques intrinsèques du produit. N.B.: Portes, façades et panneaux plaqués bois, non fournis avec veinage continu lorsqu'adjacents, sauf pour les finitions WD Eucalyptus Fumé Mat et Brillant

Atención: debido a la naturaleza del material, las pequeñas deferencias en el tono/efecto no deben considerarse defectos, sino características intrinsecas del producto

NOTA: Las puertas, los frentes y los paneles enchapados de madera, si son adyacentes, no se suministran con continuidad de vena, a excepción de los acabados WD Eucalipto Humo Satinado y Brillo

WAY Finiture

Finishes / Finitions / Acabados

IMPIALLACCIATI LEGNO VERNICIATO POLIESTERE

WOOD VENEERS PAINTED POLYESTER / PLAQUÉS BOIS PEINTS POLYESTER / ENCHAPADOS MADERA PINTADOS DE POLIÉSTER

Colonna prezzo / Price column
Colonne prix / Columna precio

9



WD **EUCALIPTO AFFUMICATO FRISE SATINATO** / MATT FUME EUCALYPTUS
EUCALYPTUS FUMÉ MAT / EUCALIPTO HUMO SATINADO



WD **EUCALIPTO AFFUMICATO FRISE LUCIDO** / HIGH GLOSS FUME EUCALYPTUS
EUCALYPTUS FUMÉ BRILLANT / EUCALIPTO HUMO BRILLO



WS **EUCALIPTO GRIGIO SCURO SATINATO** / MATT NIGHT EUCALYPTUS
EUCALYPTUS GRIS FONCÉ MAT / EUCALIPTO GRIS OSCURO SATINADO



WS **EUCALIPTO GRIGIO SCURO LUCIDO** / NIGHT EUCALYPTUS high-gloss
EUCALYPTUS GRIS FONCÉ brillant / EUCALIPTO GRIS OSCURO BRILLANTE

Attenzione: a causa della natura del materiale, leggere differenze di tono/effetto non sono da potersi considerare difetti ma caratteristiche intrinseche del prodotto.
N.B.: Ante, facciate e pannelli impiallacciati legno, qualora adiacenti, non vengono forniti in continuità di vena fatta eccezione per le finiture WD Eucalypto Affumicato Frise Satinato e Lucido
Non disponibile per ante > 220,6

Attention: please note that due to the nature, slight variations in the tone/effect shall not be viewed as defects but intrinsic peculiarities of product.
NOTE: Doors, fronts and wood veneered panels, if adjacent, are not supplied in continuity of vein except for the Satin and Glossy Smoked Eucalyptus Frisée WD finishes.
Not available for doors > 220,6

Attention: en raison de la nature de la matière, des légères variations de tonalité/effet ne sont pas des défauts mais des caractéristiques intrinsèques du produit.
N.B.: Portes, façades et panneaux plaqués bois, non fournis avec veinage continu lorsqu'adjacents, sauf pour les finitions WD Eucalyptus Fumé Mat et Brillant
Pas disponibles pour portes > 220,6

Atención: debido a la naturaleza del material, las pequeñas deferencias en el tono/efecto no deben considerarse defectos, sino características intrínsecas del producto
NOTA: Las puertas, los frentes y los paneles enchapados de madera, si son adyacentes, no se suministran con continuidad de vena, a excepción de los acabados WD Eucalypto Humo Satinado y Brillo
No disponible para puertas > 220,6

WAY MATERIA Finiture

Finishes / Finitions / Acabados

VETRI LUCIDI / TELAIO ALLUMINIO

HIGH GLOSS GLASSES / ALUMINUM FRAME / VERRES BRILLANTS / CADRE ALUMINIUM / VIDRIOS BRILLOS / MARCO ALUMINIO

Colonna prezzo / Price column
Colonne prix / Columna precio

7



1V **BIANCO ARTICO** / ARCTIC WHITE
BLANC ARCTIQUE / BLANCO ÁRTICO

Attenzione: in caso di sostituzioni o completamenti a causa della natura del materiale, leggere differenze di tono/effetto non sono da potersi considerare difetti ma caratteristiche intrinseche del prodotto.

Attention: please note that due to the nature, slight variations in the tone/effect, occurring in case of remedials or additional parts, shall not be viewed as defects but intrinsic peculiarities of product.

Attention: en raison de la nature de la matière, en cas de remplacements ou éléments supplémentaires, des légères variations de tonalité/effet ne sont pas des défauts mais des caractéristiques intrinsèques du produit.

Atención: en caso de reemplazos o pedidos adicionales, debido a la naturaleza del material, las pequeñas deferencias en el tono/efecto no deben considerarse defectos, sino características intrínsecas del producto

VETRI LUCIDI / TELAIO ALLUMINIO

HIGH GLOSS GLASSES / ALUMINUM FRAME / VERRES BRILLANTS / CADRE ALUMINIUM / VIDRIOS BRILLOS / MARCO ALUMINIO

Colonna prezzo / Price column
Colonne prix / Columna precio

8



2B **GRIGIO PIUMA** / FEATHER GREY
GRIS PLUME / GRIS PLUMA



E2 **GRIGIO ATLANTICO** / ATLANTIC GREY
GRIS ATLANTIQUE / GRIS ATLÁNTICO



F2 **GRIGIO GRAFITE** / GRAPHITE GREY
GRIS GRAPHITE / GRIS GRAFITO

Attenzione: in caso di sostituzioni o completamenti a causa della natura del materiale, leggere differenze di tono/effetto non sono da potersi considerare difetti ma caratteristiche intrinseche del prodotto.

Attention: please note that due to the nature, slight variations in the tone/effect, occurring in case of remedials or additional parts, shall not be viewed as defects but intrinsic peculiarities of product.

Attention: en raison de la nature de la matière, en cas de remplacements ou éléments supplémentaires, des légères variations de tonalité/effet ne sont pas des défauts mais des caractéristiques intrinsèques du produit.

Atención: en caso de reemplazos o pedidos adicionales, debido a la naturaleza del material, las pequeñas deferencias en el tono/efecto no deben considerarse defectos, sino características intrínsecas del producto

VETRI OPACHI / TELAIO ALLUMINIO

SATIN GLASSES / ALUMINUM FRAME / VERRES DÉPOLIS / CADRE ALUMINIUM / VIDRIOS MATE / MARCO ALUMINIO

Colonna prezzo / Price column
Colonne prix / Columna precio

8

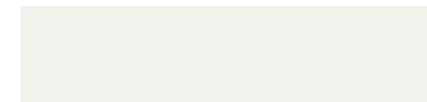

1V **BIANCO ARTICO** / ARCTIC WHITE
BLANC ARCTIQUE / BLANCO ÁRTICO

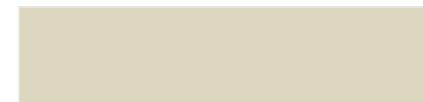

2B **GRIGIO PIUMA** / FEATHER GREY
GRIS PLUME / GRIS PLUMA



E2 **GRIGIO ATLANTICO** / ATLANTIC GREY
GRIS ATLANTIQUE / GRIS ATLÁNTICO



F2 **GRIGIO GRAFITE** / GRAPHITE GREY
GRIS GRAPHITE / GRIS GRAFITO

Attenzione: in caso di sostituzioni o completamenti a causa della natura del materiale, leggere differenze di tono/effetto non sono da potersi considerare difetti ma caratteristiche intrinseche del prodotto.

Attention: please note that due to the nature, slight variations in the tone/effect, occurring in case of remedials or additional parts, shall not be viewed as defects but intrinsic peculiarities of product.

Attention: en raison de la nature de la matière, en cas de remplacements ou éléments supplémentaires, des légères variations de tonalité/effet ne sont pas des défauts mais des caractéristiques intrinsèques du produit.

Atención: en caso de reemplazos o pedidos adicionales, debido a la naturaleza del material, las pequeñas deferencias en el tono/efecto no deben considerarse defectos, sino características intrínsecas del producto

CERAMICHE / TELAIO ALLUMINIO

CERAMICS / ALUMINIUM FRAME / CÉRAMIQUES / CADRE ALUMINIUM / CERÁMICAS / MARCO EN ALUMINIO

Colonna prezzo / Price column
Colonne prix / Columna precio

9



D1 **CALCE BIANCO** / CALCE BIANCO
CALCE BIANCO / CALCE BLANCO



DG **CALCE GRIGIO** / CALCE GRIGIO
CALCE GRIGIO / CALCE GRIS

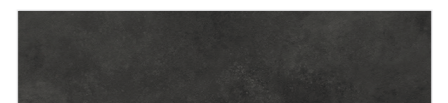

DZ **OSSIDO NERO** / OSSIDO NERO
OSSIDO NERO / ÓXIDO NEGRO

Attenzione: a causa della natura del materiale, leggere differenze di tono/effetto non sono da potersi considerare difetti ma caratteristiche intrinseche del prodotto.

Attention: please note that due to the nature, slight variations in the tone/effect shall not be viewed as defects but intrinsic peculiarities of product.

Attention: en raison de la nature de la matière, des légères variations de tonalité/effet ne sont pas des défauts mais des caractéristiques intrinsèques du produit.

Atención: debido a la naturaleza del material, las pequeñas deferencias en el tono/efecto no deben considerarse defectos, sino características intrínsecas del producto

WAY Profili gola piatta

Flat-channel profiles / Profils à gorge plane / Perfil gola plana

ALLUMINIO ANODIZZATO

ANODIZED ALUMINUM / ALUMINIUM ANODISÉ / ALUMINIO ANODIZADO



H7 TITANIO / TITANIUM
TITANE / TITANIO



90 NERO / BLACK
NOIR / NEGRO

ALLUMINIO VERNICIATO A POLVERI

POWDER-COATED ALUMINUM / ALUMINIUM LAQUÉ POWDRE / ALUMINIO BARNIZADO CON POLVO



01 BIANCO / WHITE
BLANC / BLANCO



2U GRIGIO POLVERE / POWDER GREY
GRIS POWDRE / GRIS POLVO

(01 BIANCO abbinabile a anta A1 e 1V BIANCO ARTICO)
(2U GRIGIO POLVERE abbinabile a anta F2 GRIGIO GRAFITE)

(01 WHITE matching A1 and 1V ARCTIC WHITE door)
(2U POWDER GREY matching F2 GRAPHITE GREY door)

(01 BLANC assorti à la porte A1 et 1V BLANC ARCTIQUE)
(2U GRIS POWDRE assorti à porte F2 GRIS GRAPHITE)

(01 BLANCO combinable con puerta A1 y 1V BLANCO ARTICO)
(2U GRIS POLVO combinable con puerta F2 GRIS GRAFITO)

WAY Profili gola piatta

Flat-channel profiles / Profils à gorge plane / Perfil gola plana

ALLUMINIO VERNICIATO LIQUIDO OPACO

LIQUID MATT-PAINTED ALUMINUM / ALUMINIUM LAQUÉ LIQUIDE MAT / ALUMINIO BARNIZADO LIQUIDO MATE



0W BIANCO LUCE / REFLECT WHITE
BLANC LUMIÈRE / BLANCO LUZ



20 GRIGIO PERLA / PEARL GREY
GRIS PERLE / GRIS PERLA



2A TITANIO / TITANIUM
TITANE / TITANIO



D7 GIALLO SAHARA / SAHARA YELLOW
JAUNE SAHARA / AMARILLO SAHARA



31 ROSSO ITALIA / RACING RED
ROUGE ITALIA / ROJO ITALIA



C4 VERDE CEDRO / CEDAR GREEN
VERT CÈDRE / VERDE CEDRO



F5 AZZURRO SVEZIA / SWEDEN BLUE
BLEU SUÈDE / CELESTE SUECIA



8A MARRONE FRUMENTO / WHEAT BROWN
MARRON FROMENT / MARRÓN TRIGO



81 MARRONE TERRA / EARTH BROWN
MARRON TERRE / MARRÓN TIERRA



2B GRIGIO PIUMA / FEATHER GREY
GRIS PLUME / GRIS PLUMA



2Q GRIGIO URANO / COSMIC GREY
GRIS URANUS / GRIS URANO



7J GIALLO LEMON / LEMON YELLOW
JAUNE CITRON / AMARILLO LEMON



6N ARANCIO AUTUNNALE / AUTUMN ORANGE
ORANGE AUTOMNE / NARANJA OTOÑAL



3N ROSSO GINGER / GINGER RED
ROUGE GINGER / ROJO JENGIBRE



4X TE' VERDE / TEA GREEN
VERT THÉ / VERDE TÉ



5T BLU PATAGONIA / PATAGONIA BLUE
BLEU PATAGONIE / AZUL PATAGONIA



8V CAPPUCCINO / CAPPUCCINO
CAPPUCCINO / CAPUCHINO



9B NERO OMBRA / SHADOW BLACK
NOIR OMBRE / NEGRO SOMBRA



1A AVORIO / IVORY
IVOIRE / MARFIL



2S GRIGIO PLATINO / PLATINUM GREY
GRIS PLATINE / GRIS PLATINO



73 GIALLO CURRY / CURRY YELLOW
JAUNE CURRY / AMARILLO CURRY



K3 ROSSO PECHINO / BEIJING RED
ROUGE PEKIN / ROJO PEKÍN



3E ROSSO MARSALA / MARSALA RED
ROUGE MARSALA / ROJO MARSALA



4E VERDE FELCE / FERN GREEN
VERT FOUGÈRE / VERDE HELECHO



5V BLU LAGO / LAKE BLUE
BLEU LAC / AZUL LAGO



8H MARRONE CAFFÈ / COFFEE BROWN
MARRON CAFÉ / MARRÓN CAFÉ



2J PELTRO / PEWTER
ÉTAIN / PELTRE

